

FEB219-001 User's Guide  
FPP06R001  
Evaluation Board

Featured Fairchild Product: FPP06R001

[www.fairchildsemi.com/FEBsupport](http://www.fairchildsemi.com/FEBsupport)

## Table of Contents

1. Introduction.....	3
2. Features .....	3
3. Description .....	3
4. Schematics .....	4
5. PCB Layout.....	5
6. List of Materials.....	7
7. Test Setup .....	8
8. Circuit Operation .....	9

The following user guide supports the demonstration kit for the FPP06R001. It should be used in conjunction with the FPP06R001 datasheet as well as Fairchild application notes and technical support team. Please visit Fairchild's website at [www.fairchildsemi.com](http://www.fairchildsemi.com).

## 1. Introduction

The synchronous rectifiers are widely accepted for high efficiency in power conversion applications. Because they utilize power MOSFETs versus Schottky diodes, low  $R_{DS(ON)}$  is a very significant parameter for synchronous rectification switches. An integrated switch has been introduced as optimized solution for this application. This guide describes benefits of an integrated solution and provides necessary information to evaluate it.

## 2. Features

- Power SPM, integrated power MOSFETs and high current gate driver in a single transfer molded package
- 75V, 3.6mOhm(typical) power switches and 2.5A capability gate driver IC
- Forward topology with synchronous rectifier operates at 100kHz
- 380V input
- 12V output at 20A
- 91.7% efficiency at full load

## 3. Description

The Power SPM demo board has designed to demonstrate FPP06R001 functionality and how it can be implemented. A single-ended forward topology with RCD clamp is used as primary DC-DC converter. A switch-mode power supply controller, KA7553A controls the forward converter. The FPP06R001 serves as secondary-side synchronous rectifier. NOR gates are used for creating the driving signals for the FPP06R001, and two pulse transformers pass the signals to secondary-side. By adjusting resistance of R15, dead time between freewheeling switch turn-off and forwarding switch turn-on can be varied. Initial value of R15 is set to 1.8kOhm. Also R23 determines dead time between forwarding switch turn-off and freewheeling switch turn-on. Initial value of R23 is 100kOhm.

## 4. Schematics

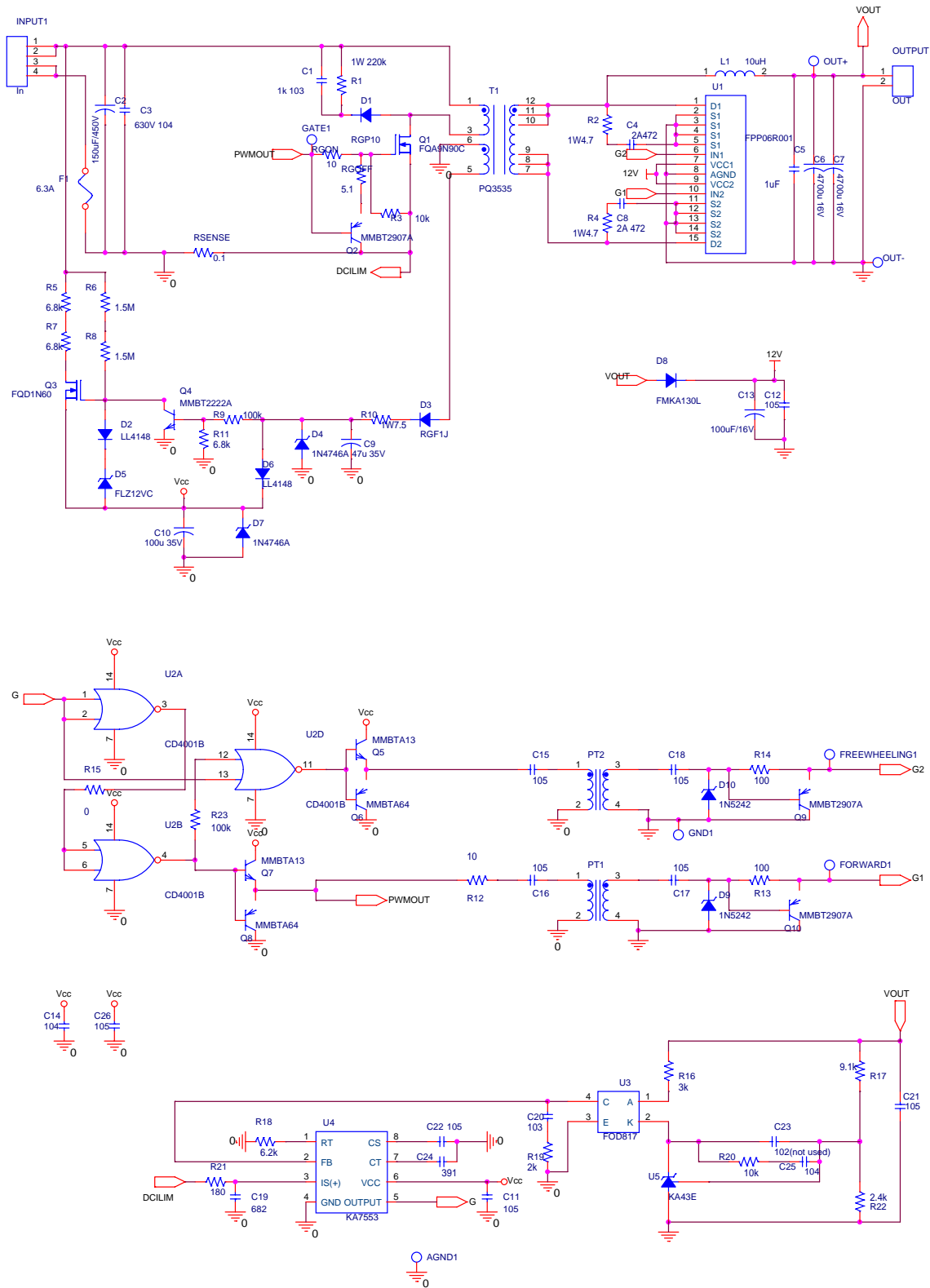

## 5. PCB Layout

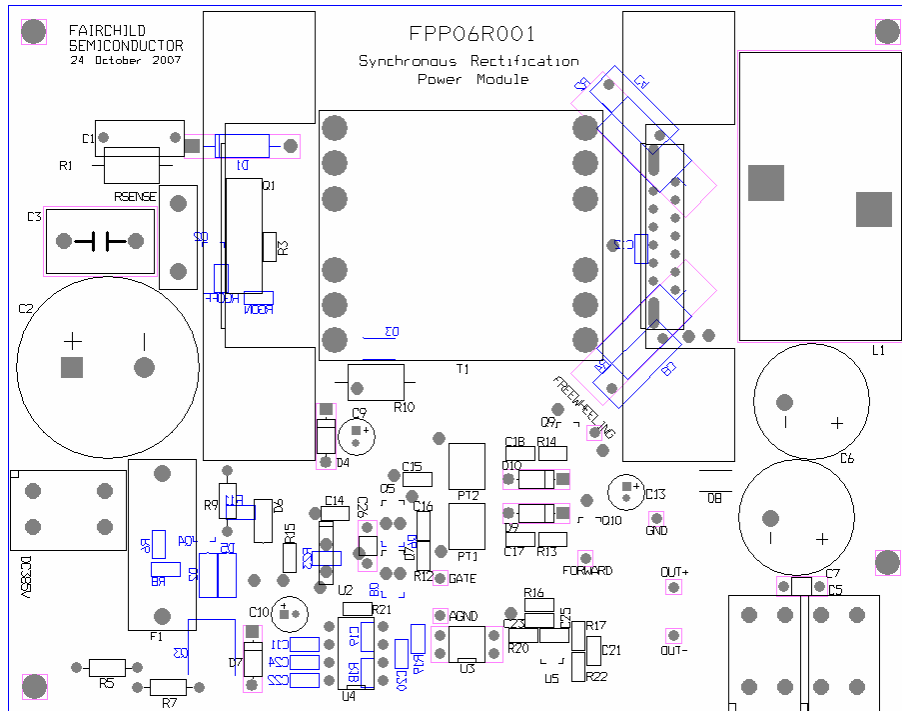

< Component assembly >

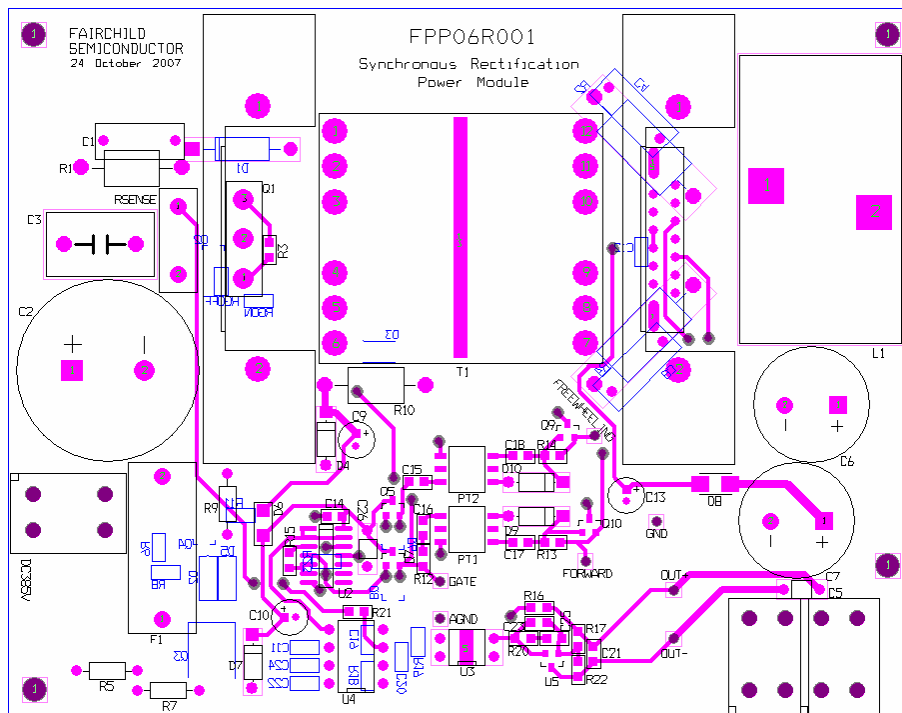

< Top layer >

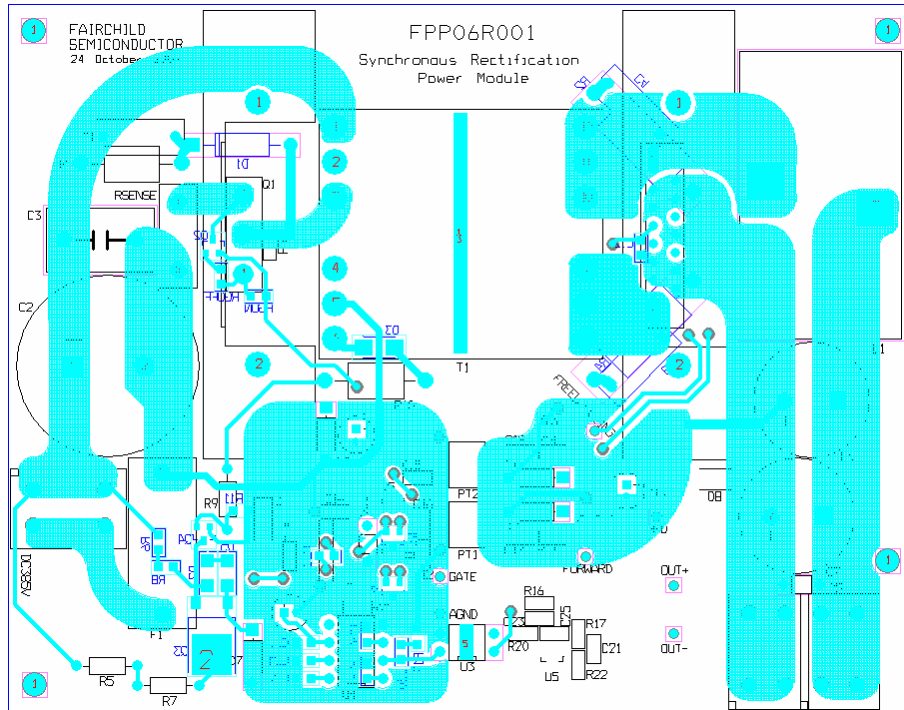

< Bottom layer >

## 6. List of Materials

Reference Designator	Total Quantity	Value	Description	Manufacturer	Package
C1	1	103	Capacitor, Ceramic, 1KV		
C2	1	150uF	Capacitor, Aluminum, 450V		
C3 (not used)	1	104	Capacitor, Film, 630V		
C4, C8	2	472	Capacitor, Ceramic, 100V		
C5, C26	2	105	Capacitor, Ceramic, 25V		
C6, C7	2	4700uF	Capacitor, Aluminum, 16V		
C9	1	47uF	Capacitor, Aluminum, 35V		
C10	1	100uF	Capacitor, Aluminum, 35V		
C11, C12, C15, C16, C17, C18, C21, C22	8	105	Capacitor, SMD, 2012		
C13	1	100uF	Capacitor, Aluminum, 16V		
C14, C25	2	104	Capacitor, SMD, 2012		
C19	1	682	Capacitor, SMD, 2012		
C20	1	103	Capacitor, SMD, 2012		
C23 (not used)	1	102	Capacitor, SMD, 2012		
C24	1	391	Capacitor, SMD, 2012		
D1	1	RGP10M	1000V, 1A, Fast Recoverv	Fairchild	DO- 41
D2, D6	2	LL4148	Small Signal Diode	Fairchild	SOD80
D3	1	RGF1J	600V, 1A, Fast Recoverv Rectifier	Fairchild	SMA
D4, D7	2	1N4746A	Zener Diode, 18V, 1W	Fairchild	DO- 41
D5	1	FLZ12VC	Zener Diode, 12V, 0.5W	Fairchild	SOD80
D8	1	FMKA130L	30V, 1A, Schottky Diode	Fairchild	SMA
D9 (optional), D10 (optional)	2	1N5242B	Zener Diode, 12V, 0.5W	Fairchild	DO- 35
F1	1	6.3A	Fuse		
L1	1	10uH	Inductor		
PT1, PT2	2	DA2318	Transformer, 1.5:1	Coilcraft	
Q1	1	FQA9N90C	900V, 1.4ohm, QFET	Fairchild	TO- 3P
Q2, Q9, Q10	3	MMBT2907A	Transistor, PNP	Fairchild	SOT- 23
Q3	1	FQD1N60C	600V, 11.5ohm, QFET	Fairchild	DPAK
Q4	1	MMBT2222A	Transistor, NPN	Fairchild	SOT- 23
Q5, Q7	2	MMBTA13	NPN Darlington Transistor	Fairchild	SOT- 23
Q6, Q8	2	MMBTA64	PNP Darlington Transistor	Fairchild	SOT- 23
RGON	1	10	Resistor, SMD, 2012		
RGOFF	1	5.1	Resistor, SMD, 2012		
R1	1	220k	Resistor, 1W		
R2, R4	2	4.7	Resistor, 1W		
R3, R20	2	10k	Resistor, SMD, 2012		
R5, R7	2	6.8k	Resistor, 1/4W		
R6, R8	2	1.5M	Resistor, SMD, 2012		
R9	1	100k	Resistor, 1/4W		
R10	1	7.5	Resistor, 1W		
R11	1	6.8k	Resistor, SMD, 2012		
R12	1	10	Resistor, SMD, 2012		
R13, R14	2	100	Resistor, SMD, 2012		
R15	1	1.8k	Resistor, SMD, 2012		
R16	1	3k	Resistor, SMD, 2012		
R17	1	9.1k	Resistor, SMD, 2012		
R18	1	6.2k	Resistor, SMD, 2012		
R19	1	2k	Resistor, SMD, 2012		
R21	1	180	Resistor, SMD, 2012		
R22	1	2.4k	Resistor, SMD, 2012		
R23	1	100k	Resistor, SMD, 2012		
T1	1	PQ3535	Transformer		
Terminal	6	USL- 5SB1	Screwless Terminal	Seoil	
Heatsink	2	02HN	5.7C/W	HS Marston	
U1	1	FPP06R001	Power SPM	Fairchild	EPM15
U2	1	CD4001BCM	Quad 2- Input NOR	Fairchild	14- SOIC
U3	1	FOD817	Optocoupler	Fairchild	4- DIP
U4	1	KA7553A	SMPS Controller	Fairchild	8- DIP
U5	1	KA431SAME2	Shunt Regulator, 1%	Fairchild	SOT- 23

## 7. Test Setup

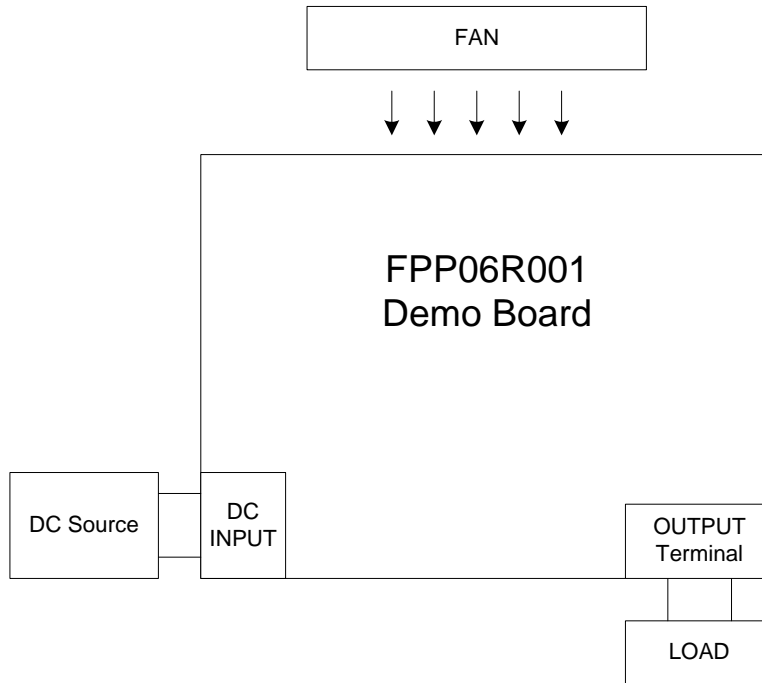

The above picture is the basic test setup needed to evaluate FPP06R001 demo board. A programmable electronic load that has constant current mode and current sink capability up to 20A is used for the output load. Load current beyond 20A may cause permanent damage to the system.

Nominal input voltage from DC source is 380V. Recommended input range is from 360V to 400V.

A fan should be used to prevent thermal failure when 10A or above load current is applied.



## 8. Circuit Operation

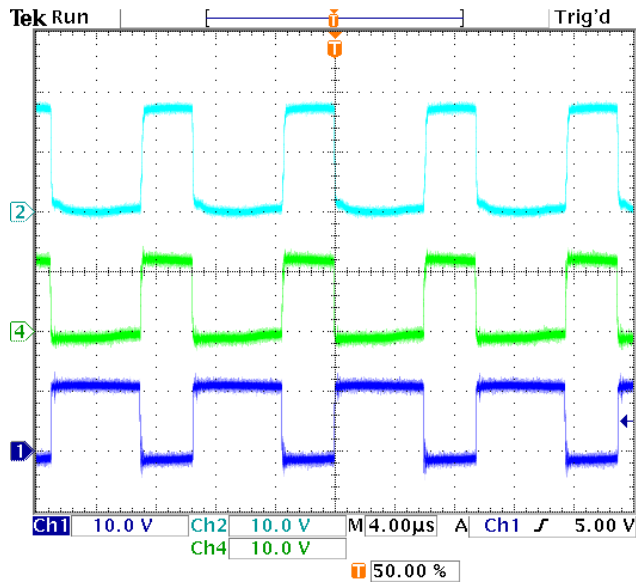

Gate driving signals at 5A load is shown above. Cyan waveform is  $V_{GS}$  of forward converter switch. Green and blue waveforms are secondary-side synchronous rectifier  $V_{IN}$  signals.

Below picture shows dead time changes according to the value of R23.

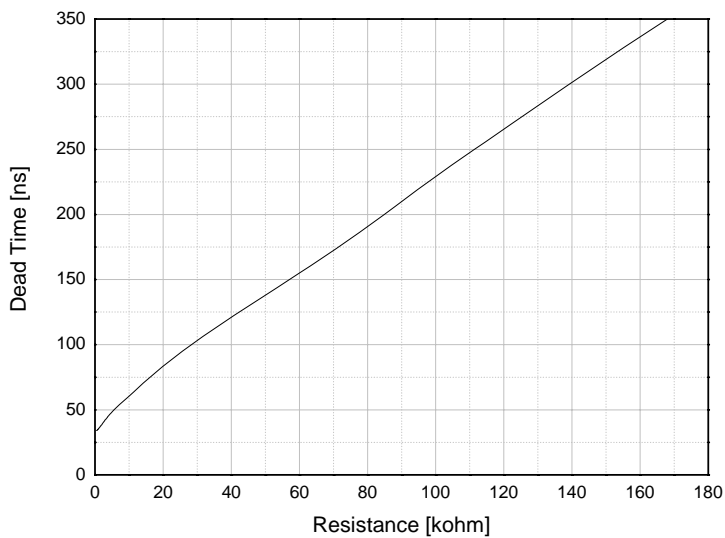

Also, the dead time between freewheeling switch turn-off and forwarding switch turn-on according to the value of R15 is shown below.

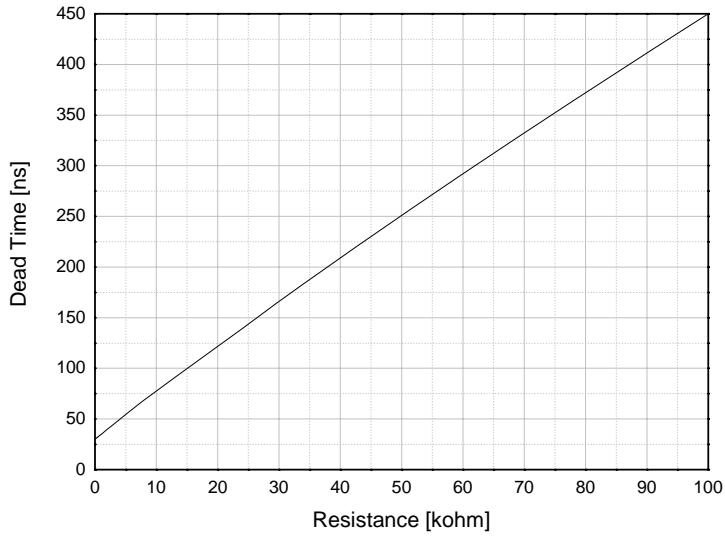

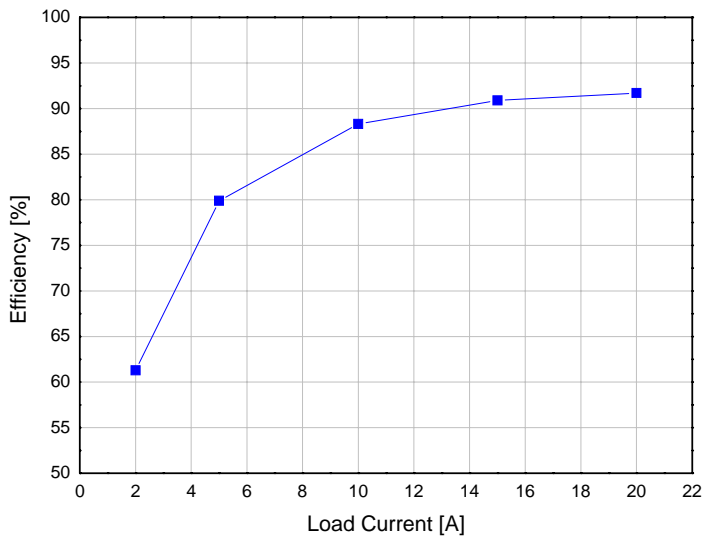

The demo board reaches 91.7% efficiency at 20A load, 380V input.



## TRADEMARKS

The following includes registered and unregistered trademarks and service marks, owned by Fairchild Semiconductor and/or its global subsidiaries, and is not intended to be an exhaustive list of all such trademarks.

ACEx <sup>®</sup>	FPS <sup>™</sup>	PDP-SPM <sup>™</sup>	SupreMOS <sup>™</sup>
Build it Now <sup>™</sup>	FRFET <sup>®</sup>	Power220 <sup>®</sup>	SyncFET <sup>™</sup>
CorePLUS <sup>™</sup>	Global Power Resource <sup>SM</sup>	POWEREDGE <sup>®</sup>	SYSTEM <sup>®</sup>
CROSSVOLT <sup>™</sup>	Green FPS <sup>™</sup>	Power-SPM <sup>™</sup>	GENERAL <sup>®</sup>
CTL <sup>™</sup>	Green FPS <sup>™</sup> e-Series <sup>™</sup>	PowerTrench <sup>®</sup>	The Power Franchise <sup>®</sup>
Current Transfer Logic <sup>™</sup>	GTO <sup>™</sup>	Programmable Active Droop <sup>™</sup>	<b>the power</b>
EcoSPARK <sup>®</sup>	i-Lo <sup>™</sup>	QFET <sup>®</sup>	franchise
EZSWITCH <sup>™</sup> *	IntelliMAX <sup>™</sup>	QS <sup>™</sup>	TinyBoost <sup>™</sup>
 ™	ISOPLANAR <sup>™</sup>	QT Optoelectronics <sup>™</sup>	TinyBuck <sup>™</sup>
 ™	MegaBuck <sup>™</sup>	Quiet Series <sup>™</sup>	TinyLogic <sup>®</sup>
Fairchild <sup>®</sup>	MICROCOUPLER <sup>™</sup>	RapidConfigure <sup>™</sup>	TINYOPTO <sup>™</sup>
Fairchild Semiconductor <sup>®</sup>	MicroFET <sup>™</sup>	SMART START <sup>™</sup>	TinyPower <sup>™</sup>
FACT Quiet Series <sup>™</sup>	MicroPak <sup>™</sup>	SPM <sup>®</sup>	TinyPWM <sup>™</sup>
FACT <sup>®</sup>	MillerDrive <sup>™</sup>	STEALTH <sup>™</sup>	TinyWire <sup>™</sup>
FAST <sup>®</sup>	Motion-SPM <sup>™</sup>	SuperFET <sup>™</sup>	µSerDes <sup>™</sup>
FastvCore <sup>™</sup>	OPTOLOGIC <sup>®</sup>	SuperSOT <sup>™</sup> -3	UHC <sup>®</sup>
FlashWriter <sup>®</sup> *	OPTOPLANAR <sup>®</sup>	SuperSOT <sup>™</sup> -6	Ultra FRFET <sup>™</sup>
	 ™	SuperSOT <sup>™</sup> -8	UniFET <sup>™</sup>
			VCX <sup>™</sup>

\* EZSWITCH<sup>™</sup> and FlashWriter<sup>®</sup> are trademarks of System General Corporation, used under license by Fairchild Semiconductor.

## WARNING AND DISCLAIMER

Replace components on the Evaluation Board only with those parts shown on the parts list (or Bill of Materials) in the Users' Guide. Contact an authorized Fairchild representative with any questions.

The Evaluation board (or kit) is for demonstration purposes only and neither the Board nor this User's Guide constitute a sales contract or create any kind of warranty, whether express or implied, as to the applications or products involved. Fairchild warrants that its products meet Fairchild's published specifications, but does not guarantee that its products work in any specific application. Fairchild reserves the right to make changes without notice to any products described herein to improve reliability, function, or design. Either the applicable sales contract signed by Fairchild and Buyer or, if no contract exists, Fairchild's standard Terms and Conditions on the back of Fairchild invoices, govern the terms of sale of the products described herein.

## DISCLAIMER

FAIRCHILD SEMICONDUCTOR RESERVES THE RIGHT TO MAKE CHANGES WITHOUT FURTHER NOTICE TO ANY PRODUCTS HEREIN TO IMPROVE RELIABILITY, FUNCTION, OR DESIGN. FAIRCHILD DOES NOT ASSUME ANY LIABILITY ARISING OUT OF THE APPLICATION OR USE OF ANY PRODUCT OR CIRCUIT DESCRIBED HEREIN; NEITHER DOES IT CONVEY ANY LICENSE UNDER ITS PATENT RIGHTS, NOR THE RIGHTS OF OTHERS.

## LIFE SUPPORT POLICY

FAIRCHILD'S PRODUCTS ARE NOT AUTHORIZED FOR USE AS CRITICAL COMPONENTS IN LIFE SUPPORT DEVICES OR SYSTEMS WITHOUT THE EXPRESS WRITTEN APPROVAL OF THE PRESIDENT OF FAIRCHILD SEMICONDUCTOR CORPORATION.

As used herein:

1. Life support devices or systems are devices or systems which, (a) are intended for surgical implant into the body, or (b) support or sustain life, or (c) whose failure to perform when properly used in accordance with instructions for use provided in the labeling, can be reasonably expected to result in significant injury to the user.
2. A critical component is any component of a life support device or system whose failure to perform can be reasonably expected to cause the failure of the life support device or system, or to affect its safety or effectiveness.